



SC41 Series



1/4" NPT Stainless Steel Body 2-Way Direct Acting Normally Closed



Materials	Seals:	FKM, EPDM, Nitrile, PTFE, FFKM
	Orifice:	Stainless Steel
Electrical	Standard Housing:	DIN 43650 Form A
	Optional Housings:	18" Leads
	Standard Voltages:	24, 120, 220AC 60Hz; 50Hz available; 12, 24 DC; Contact GC Valves Customer Service for Additional Voltages.
	Voltage Tolerance:	±10% of applicable voltage
	Coil Class:	H
Operating Temperature	Ambient (Nominal):	32°F to 125°F
Mounting	Position:	Any
Approvals*	Agencies:	cURus, CE

*Not Available for all variations

Dimensions

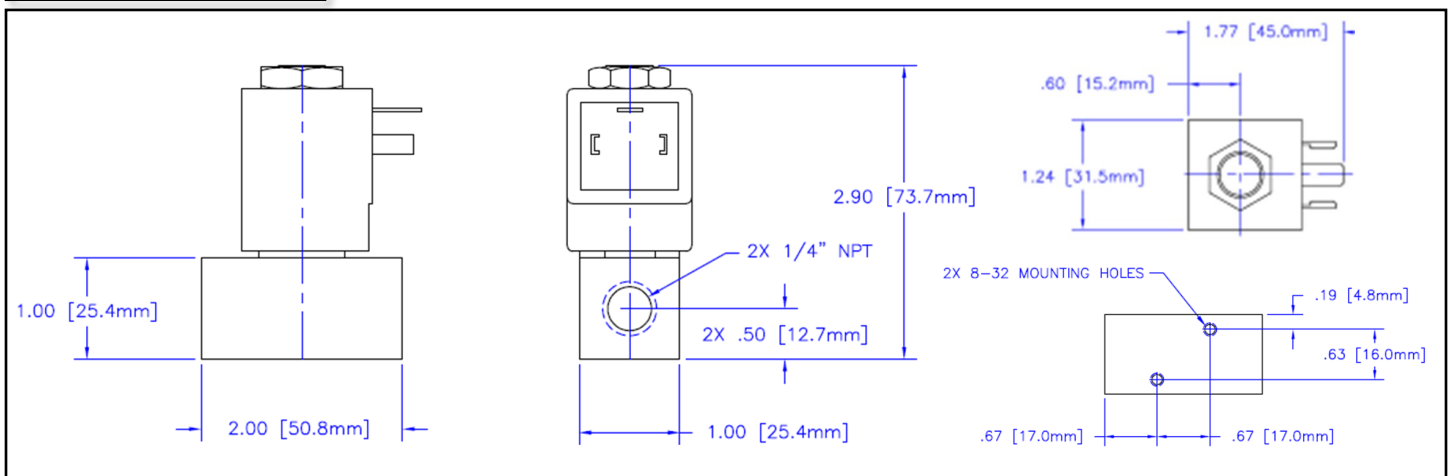



SC411-1/4" NPT, Stainless Steel, Normally Closed



Valve Selection List

Normally Closed

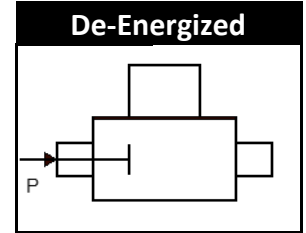
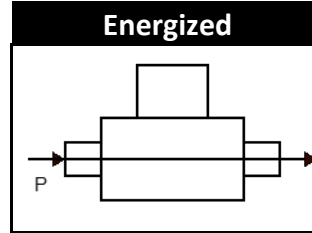
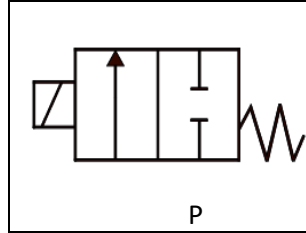

Pipe Size	Orifice Size	Cv	Operating Pressure Differential (PSI)				Max. Fluid Temp.	Seal Material	Power Consumption		Model Code (24V/60HZ - DIN) Shown	
			Min.	Maximum		AC : Watts			DC : Watts			
				Air/Gas	Water							
NPT	mm.			AC	DC	AC	DC	°F			SS Body	
1/4	0.5	0.011	0	2030	1450	2030	1450	230	FKM	8	10	SC411YN24VDBB0
	0.8	0.035	0	1160	870	1160	870	230	FKM	8	10	SC411YN24VDBA0
	1.0	0.054	0	1085	802	1085	802	230	FKM	8	10	SC411YN24VDBA1
	1.2	0.077	0	1015	735	1015	735	230	FKM	8	10	SC411YN24VDBA2
	1.6	0.119	0	870	362	870	362	230	FKM	8	10	SC411YN24VDBA3
	2.0	0.175	0	580	290	580	290	230	FKM	8	10	SC411YN24VDBA4
	2.4	0.245	0	435	217	435	217	230	FKM	8	10	SC411YN24VDBA5
	3.0	0.315	0	261	145	261	145	230	FKM	8	10	SC411YN24VDBA6
1/4	0.5	0.011	0	2030	1450	2030	1450	295	EPDM	8	10	SC411YN24CDBB0
	0.8	0.035	0	1160	870	1160	870	295	EPDM	8	10	SC411YN24CDBA0
	1.0	0.054	0	1085	802	1085	802	295	EPDM	8	10	SC411YN24CDBA1
	1.2	0.077	0	1015	735	1015	735	295	EPDM	8	10	SC411YN24CDBA2
	1.6	0.119	0	870	362	870	362	295	EPDM	8	10	SC411YN24CDBA3
	2.0	0.175	0	580	290	580	290	295	EPDM	8	10	SC411YN24CDBA4
	2.4	0.245	0	435	217	435	217	295	EPDM	8	10	SC411YN24CDBA5
	3.0	0.315	0	261	145	261	145	295	EPDM	8	10	SC411YN24CDBA6
1/4	0.5	0.011	0	2030	1450	2030	1450	180	NITRILE	8	10	SC411YN24NDBB0
	0.8	0.035	0	1160	870	1160	870	180	NITRILE	8	10	SC411YN24NDBA0
	1.0	0.054	0	1085	802	1085	802	180	NITRILE	8	10	SC411YN24NDBA1
	1.2	0.077	0	1015	735	1015	735	180	NITRILE	8	10	SC411YN24NDBA2
	1.6	0.119	0	870	362	870	362	180	NITRILE	8	10	SC411YN24NDBA3
	2.0	0.175	0	580	290	580	290	180	NITRILE	8	10	SC411YN24NDBA4
	2.4	0.245	0	435	217	435	217	180	NITRILE	8	10	SC411YN24NDBA5
	3.0	0.315	0	261	145	261	145	180	NITRILE	8	10	SC411YN24NDBA6



SC411-1/4" NPT, Stainless Steel, Normally Closed



Valve Selection List

Normally Closed

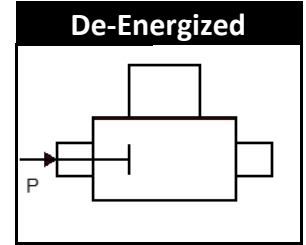
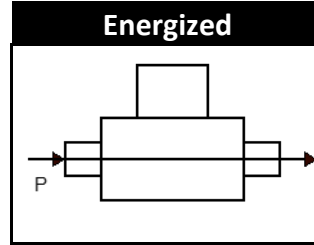
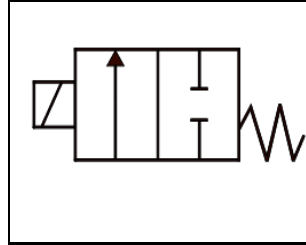

Pipe Size	Orifice Size	Cv	Min.	Operating Pressure Differential (PSI)				Max. Fluid Temp. °F	Seal Material	Power Consumption		Model Code (24V/60HZ - DIN) Shown SS Body
				Maximum						AC : Watts	DC : Watts	
				Air/Gas		Water						
NPT	mm.			AC	DC	AC	DC		AC	DC		
1/4	0.5	0.011	0	2030	1450	2030	1450	366	PTFE	8	10	SC411YN24TDBB0
	0.8	0.035	0	1160	870	1160	870	366	PTFE	8	10	SC411YN24TDBA0
	1.0	0.054	0	1085	802	1085	802	366	PTFE	8	10	SC411YN24TDBA1
	1.2	0.077	0	1015	735	1015	735	366	PTFE	8	10	SC411YN24TDBA2
	1.6	0.119	0	870	362	870	362	366	PTFE	8	10	SC411YN24TDBA3
	2.0	0.175	0	580	290	580	290	366	PTFE	8	10	SC411YN24TDBA4
	2.4	0.245	0	435	217	435	217	366	PTFE	8	10	SC411YN24TDBA5
	3.0	0.315	0	261	145	261	145	366	PTFE	8	10	SC411YN24TDBA6
1/4	0.5	0.011	0	2030	1450	2030	1450	295	FFKM	8	10	SC411YN24ADBB0
	0.8	0.035	0	1160	870	1160	870	295	FFKM	8	10	SC411YN24ADBA0
	1.0	0.054	0	1085	802	1085	802	295	FFKM	8	10	SC411YN24ADBA1
	1.2	0.077	0	1015	735	1015	735	295	FFKM	8	10	SC411YN24ADBA2
	1.6	0.119	0	870	362	870	362	295	FFKM	8	10	SC411YN24ADBA3
	2.0	0.175	0	580	290	580	290	295	FFKM	8	10	SC411YN24ADBA4
	2.4	0.245	0	435	217	435	217	295	FFKM	8	10	SC411YN24ADBA5
	3.0	0.315	0	261	145	261	145	295	FFKM	8	10	SC411YN24ADBA6



SC411-1/4" NPT, Stainless Steel, Normally Closed



Part Numbering

1	2	3	4	5	6	7	8	9	10	11	12	13	14
S	C	4	1	1	Y	N	2	4	V	D	B	A	6
Series		Stations	Operating Mode	Housing	Coil	Voltage		Seal Material	Body Material	Pipe Size	Orifice Size		
C4 Direct Acting NPT Threads		1	1: 2Way N.C.	Y: DIN G: Leads	N: H Class	02: 120/60 04: 220/60 24: 24/60 15: 12 VDC 16: 24 VDC		V: FKM C: EPDM N: Nitrile T: PTFE A: FFKM	D: SS	B: 1/4"	B0: 0.5mm A0: 0.8mm A1: 1.0mm A2: 1.2mm A3: 1.6mm A4: 2.0mm A5: 2.4mm A6: 3.0mm		

Coil Data

AC Coil Family	
Voltage Code	Coil Number
YN02	C233
GN02	C233L
YN04	C204
GN04	C204L
YN24	C727
GN24	C727L

DC Coil Family	
Voltage Code	Coil Number
YN15	C211
GN15	C211L
YN16	C212
GN16	C212L

Kit Data

Operator	
Seal	Part Number
V	KSC4102VDA6
C	KSC4102CDA6
N	KSC4102NDA6
T	KSC4102TDA6
A	KSC4102ADA6