

S31 Series

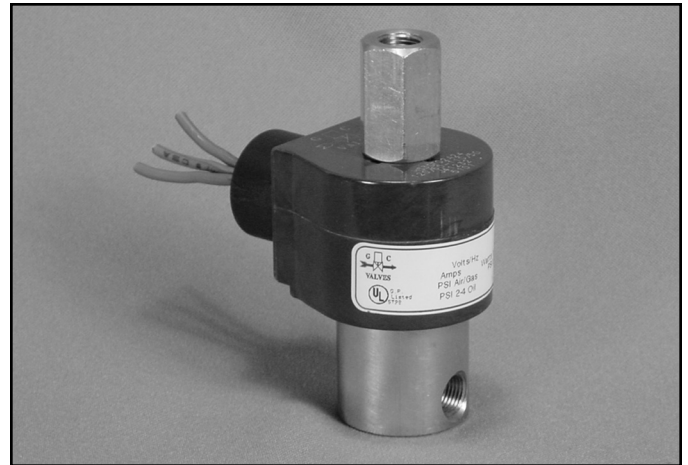

- 1/8" NPT
- Stainless Steel Body
- 3-Way Direct Acting
- Diverting



Materials	Seals:	Nitrile, Viton®, Ethylene Propylene or Teflon®
	Orifices: Top Main	Stainless Steel Stainless Steel
Electrical	Standard Housing:	Encapsulated Waterproof Conduit (NEMA 4/4X)
	Optional Housings:	Metallic Conduit, Explosion-proof (NEMA 7), Grommet, Open Frame, Junction Box (single or dual knockouts), DIN; Contact GC Valves Customer Service for others.
	Standard Voltages:	24, 120, 240 AC 60 Hz; 50 Hz available 6, 12, 24 DC; Contact GC Valves Customer Service for Additional Voltages.
	Voltage Tolerance:	±10% of applicable voltage
	Coil Classes:	F, H, N
	Standard Lead Length:	24 inch
Operating Temperature	Ambient (Nominal):	32°F to 125°F
Mounting	Position	Any
Approvals*	Agency	UL Listed, UL Recognized, CSA Approved

* Not available for all variations

® Registered Trademark of DuPont Co.

Dimensions/Weight

Weight (lbs.)
1.0

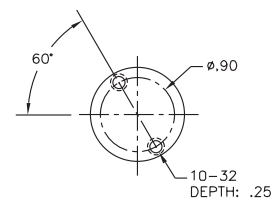
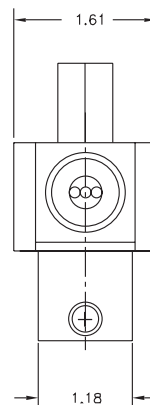
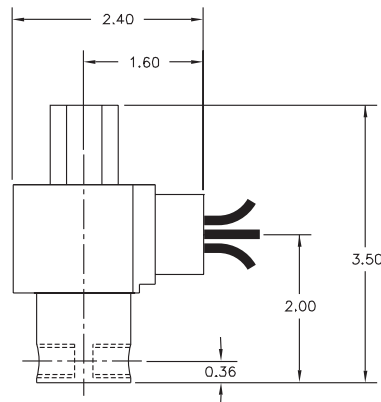

GC Valves Customer Service: 800-828-0484 (7:30am to 4pm ET) or 800-582-4232 (7:30am to 4pm PT)



S315 – 1/8" NPT, Stainless Steel Body, Diverting

Valve Selection List

Diverting

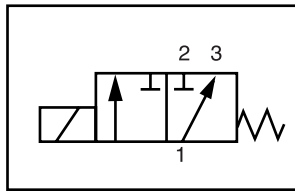

Energized

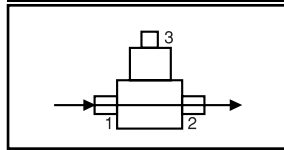

De-Energized

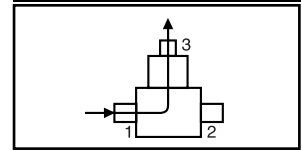

Pipe Size NPT	Orifice Size IN		C _v		Operating Pressure Differential (psi)						Max Fluid Temp. °F	Seal Material	Power Consumption (Watts)		Model Code (120V/60HZ — 110V/50HZ Shown)
	Main	Top	Main	Top	Maximum								AC	DC	
					Air/Gas		Water		Light Oil						
	AC	DC	AC	DC	AC	DC	AC	DC	AC	DC			Stainless Steel Body		
1/8	3/64	3/64	.05	.05	200	200	200	200	—	—	295	EPR	8	9	S315GF02C2AC3
	3/64	1/16	.05	.10	175	175	175	175	—	—	295	EPR	8	9	S315GF02C2AV1
	1/16	1/16	.10	.10	150	150	150	150	—	—	295	EPR	8	9	S315GF02C2AC5
	3/32	3/64	.20	.05	140	140	140	140	—	—	295	EPR	8	9	S315GF02C2AW3
	3/32	3/32	.20	.20	130	130	130	130	—	—	295	EPR	8	9	S315GF02C2AC9
	7/64	3/32	.23	.20	100	100	100	100	—	—	295	EPR	8	9	S315GF02C2AV5
	1/8	3/32	.27	.20	90	90	90	90	—	—	295	EPR	8	9	S315GF02C2AV3
	5/64	3/32	.41	.20	70	70	70	70	—	—	295	EPR	8	9	S315GF02C2AV7
1/8	3/64	3/64	.05	.05	200	200	200	200	200	200	180	Nitrile	8	9	S315GF02N2AC3
	3/64	1/16	.05	.10	175	175	175	175	175	175	180	Nitrile	8	9	S315GF02N2AV1
	1/16	1/16	.10	.10	150	150	150	150	150	150	180	Nitrile	8	9	S315GF02N2AC5
	3/32	3/64	.20	.05	140	140	140	140	140	140	180	Nitrile	8	9	S315GF02N2AW3
	3/32	3/32	.20	.20	130	130	130	130	130	130	180	Nitrile	8	9	S315GF02N2AC9
	7/64	3/32	.23	.20	100	100	100	100	100	100	180	Nitrile	8	9	S315GF02N2AV5
	1/8	3/32	.27	.20	90	90	90	90	90	90	180	Nitrile	8	9	S315GF02N2AV3
	5/64	3/32	.41	.20	70	70	70	70	70	70	180	Nitrile	8	9	S315GF02N2AV7
1/8	3/64	3/64	.05	.05	200	200	200	200	200	200	230	Viton	8	9	S315GF02V2AC3
	3/64	1/16	.05	.10	175	175	175	175	175	175	230	Viton	8	9	S315GF02V2AV1
	1/16	1/16	.10	.10	150	150	150	150	150	150	230	Viton	8	9	S315GF02V2AC5
	3/32	3/64	.20	.05	140	140	140	140	140	140	230	Viton	8	9	S315GF02V2AW3
	3/32	3/32	.20	.20	130	130	130	130	130	130	230	Viton	8	9	S315GF02V2AC9
	7/64	3/32	.23	.20	100	100	100	100	100	100	230	Viton	8	9	S315GF02V2AV5
	1/8	3/32	.27	.20	90	90	90	90	90	90	230	Viton	8	9	S315GF02V2AV3
	5/64	3/32	.41	.20	70	70	70	70	70	70	230	Viton	8	9	S315GF02V2AV7

GC Valves Customer Service: 800-828-0484 (7:30am to 4pm ET) or 800-582-4232 (7:30am to 4pm PT)

S315 – 1/8" NPT, Stainless Steel Body, Diverting



Valve Selection List

Diverting

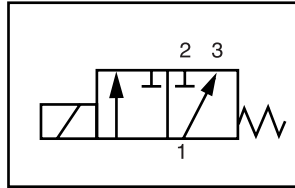

Energized

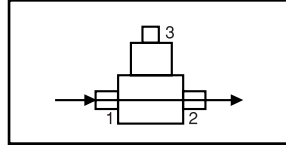

De-Energized

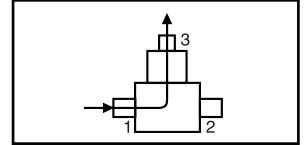

Pipe Size NPT	Orifice Size IN		C _v		Operating Pressure Differential (psi)						Max Fluid Temp. °F	Seal Material	Power Consumption (Watts)		Model Code (120V/60HZ — 110V/50HZ Shown)
					Maximum										
	Main	Top	Main	Top	Air/Gas		Water		Light Oil						
					AC	DC	AC	DC	AC	DC					
1/8	3/64	3/64	.05	.05	200	200	200	200	200	200	366*	Teflon	8	9	S315GF02T2AC3
	3/64	1/16	.05	.10	175	175	175	175	175	175	366*	Teflon	8	9	S315GF02T2AV1
	1/16	1/16	.10	.10	150	150	150	150	150	150	366*	Teflon	8	9	S315GF02T2AC5
	3/32	3/64	.20	.05	140	140	140	140	140	140	366*	Teflon	8	9	S315GF02T2AW3
	3/32	3/32	.20	.20	130	130	130	130	130	130	366*	Teflon	8	9	S315GF02T2AC9
	7/64	3/32	.23	.20	100	100	100	100	100	100	366*	Teflon	8	9	S315GF02T2AV5
	1/8	3/32	.27	.20	90	90	90	90	90	90	366*	Teflon	8	9	S315GF02T2AV3
	5/64	3/32	.41	.20	70	70	70	70	70	70	366*	Teflon	8	9	S315GF02T2AV7

* Class H Coil Recommended for High Temperature Applications



S315 – 1/8" NPT, Stainless Steel Body, Diverting

Part Numbering

1	2	3	4	5	6	7	8	9	10	11	12	13
S	3	1	5	G	F	0	2	C	2	A	C	3
Series			Operating Mode	Housing*	Coil Class*	Voltage*		Seal Material	Body Material	Pipe Connection	Orifice Size (Main x Top)	
S31			5: Diverting	G: Conduit	F: Class F	02: 120/60 110/50		C: EPR N: Nitrile V: Viton T: Teflon	2: Stainless Steel	A: 1/8" NPT	C3: 3/64" x 3/64" V1: 3/64" x 1/16" C5: 1/16" x 1/16" W3: 3/32" x 3/64" C9: 3/32" x 3/32" V5: 7/64" x 3/32" V3: 1/8" x 3/32" V7: 5/64" x 3/32"	
* See the "Engineering Guide" for additional voltages, variations and options.												

Coil Data

Coil Family	
Type	Size
All	S3

Frequency (Hz)	60	50
Nominal Power (VA)	Inrush	36
	Holding	16

GC Valves Customer Service: 800-828-0484 (7:30am to 4pm ET) or 800-582-4232 (7:30am to 4pm PT)